

REMORA
SOLO

© Remora Marine, Inc. 2019. PO Box 840, Pismo Beach, CA 93448 USA
(805)201-6301
Manual Revision R8, 09/04/2020

REMORA
SOLO

Manual of Operation, Maintenance and Use



REMORA
MARINE

© Remora Marine, Inc. 2019
www.remoramarine.com
(805) 201-6301

Specifications:

Weight	8.8 Lbs. (4 Kg)
Power	12 Volt DC, Lithium Ion Battery
Torque	6.2 Lb-Ft. (8.4 Nm)
Dimensions	15" X 5.0" X 10.7" (38 X 13 X 27cm)
Control	Electronic Variable Reversible with Pause Button
Run Time	Up to 6 Hours
Depth	0 to 36 feet (0 to 11M)
Suction	Up to 5 lbs.
Recharge	6-8 Hours
Brush Dia.	Up to 10-1/2" (265 mm)

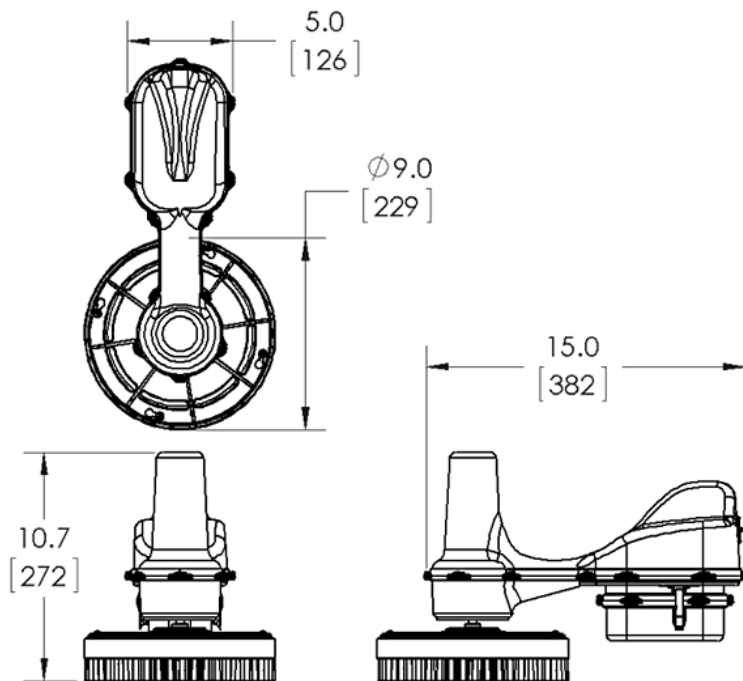

Remi is our on-staff retired USN Master Chief and he's been with the project since the beginning. He's also our mascot, although he hates being called that!



Read the instructions, there just might be some stuff you need to know in there!

Remi will give you tips and advice in his own style. Don't worry, he's here to help!

Using these Instructions:

Please read and understand all Cautions and Warnings, particularly those that concern Lithium Batteries and maintaining watertight integrity.

There are also detailed how-to videos at www.remoramarine.com/

Please read all instructions before use and refer to this manual frequently.

Contents

<u>Welcome</u>	2
<u>Cautions</u>	4-6
<u>Quick Start Guide</u>	6-7
<u>Charging and Batteries</u>	8-11
<u>Daily Maintenance</u>	12
<u>Weekly Maintenance</u>	13
<u>Using Your Remora Solo</u>	14-18
<u>Choosing a Brush</u>	15
<u>Operating the Controls</u>	16
<u>Ergonomics and Holding On</u>	17-18
<u>Removing the Battery after Use</u>	18-19
<u>Operating Characteristics</u>	20
<u>Cleaning Tips</u>	21
<u>Specifications</u>	22

READ THIS BEFORE USE

IT AFFECTS YOUR WARRANTY

Your Remora SOLO has an Electronic Speed Control (ESC) with built-in features and programming to protect the machine. Like any power tool, Remora SOLO has limits as to how hard it can be pushed, for example a small hand-held power drill will stop and wait for cool down if it is being overworked.

The ESC has Temperature Protection and Over-Current Protection. It also records many aspects of use while the machine is running in its internal memory, which we download at the factory if the unit is returned for Warranty Service.

How can you tell the Over-Current Protection is working? The machine will stop during use, then restart within one second.

The Over-Current protection will normally be invisible to you and most divers will never experience it, ***Unless You Are Pushing The Machine too hard!***

If you use excessive pressure against the surface being cleaned, Remora SOLO will let you know:

First, the machine will slow down dramatically, you can hear, feel and see the brush speed get slower.

Second, the Machine will stop for 1 second, then restart when pressure is removed from the brush. If this happens, reduce the pressure against the surface.

If the Over-Current protection is activated 3 times in One Minute (60 seconds) the machine will go into Lockout Mode for 20 seconds. During this time period if you try to restart the machine it will move the brush slightly Clockwise (CW) and Counter-Clockwise (CCW) very briefly.

After 20 seconds, the machine will alert the user that Lockout Mode is over by moving the brush CW-CCW-CW-CCW. Press the pause button and the machine will resume at the selected speed and rotation direction.

Video Available: www.remoramarine.com or <https://www.youtube.com/watch?v=2xycAFTG7S4>

If needed, you can change to a brush that is coarser (from a #3 to a #4, for example) and see if that helps. If the surface is still not getting clean with a coarser brush, you will need to slow down or try an even coarser brush or different brush shape.

If you occasionally push the machine up to its limit and the Over-Current protection kicks in, be aware that you are applying too much pressure to the brush while cleaning. By following these guidelines, you will extend the life and efficiency of your Remora SOLO.

Repeatedly and deliberately causing the Remora SOLO to reach the Over-Current shut-off is considered misuse, will damage the transmission and electronics in the unit and will void your warranty.

Tips for Using Your Remora SOLO

Submerged use tips:

Use the softest brush or pad that will get the job done.

Use the slowest speed that will get the job done.

Allow the machine to do the work. Don't fight it.

Don't apply excess pressure to the surface.

Don't scrub, just guide Remora in the direction you want to clean.

Occasionally change hands, grip and position to equalize loads on your muscles.

Cleaning with Remora SOLO will take some practice to get good at it. Most divers will take one—two full batteries before they start to become efficient with the machine. You'll have to unlearn some techniques that you used before when scrubbing by hand.

Expect to spend a few hours getting used to Remora SOLO.

Above the Waterline Cleaning tips:

Make sure the surface is kept wet while using.

Do not run Remora at greater than ½ speed for more than 5 minutes without cooling.

Spray Remora with water regularly when using on deck to cool the unit.

Use the softest brush that gets the job done.

Remora's brushes are generally safe for use on high quality marine paints and gel coats, however, test on an inconspicuous spot before using.

Please enjoy using your Remora SOLO, feel free to contact us with new uses, suggestions or feedback.

Thank You!

Notes on Buoyancy and Tuning

Buoyancy

Remora is designed to float, with minimal positive buoyancy. Your machine was shipped from the factory with about 1 oz. (28 g) of positive buoyancy in 70° F (21° C) fresh water.

This means it will float more in colder fresh water and less in warmer fresh water. It will have about 8-10% more buoyancy in salt water.

Tuning

Your Remora is supplied with a ballast compartment that allows you to reduce buoyancy by up to 1.5 oz. (43 g) through the use of stainless steel washers. It is a small change but if you find yourself working to keep the tool submerged, adding weight will help. The weights are also valuable when changing from salt to fresh or brackish water.

Ballast weights:

Using a #1 Phillips screwdriver, remove the screw in the center of the ballast compartment. Remove the plastic ballast retainer.

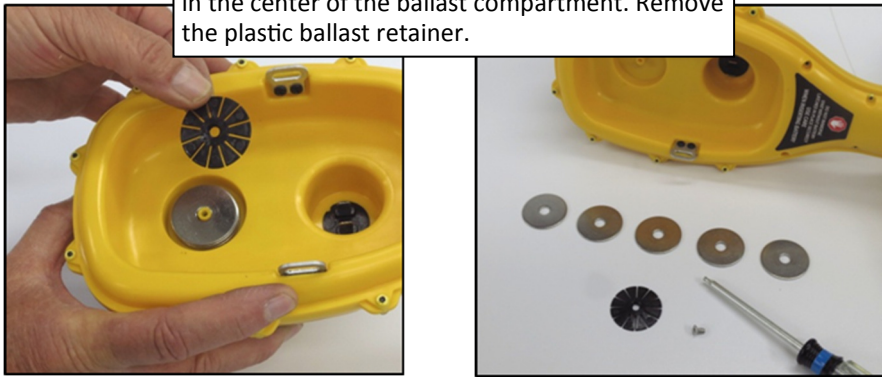

Stack the desired 1-1/2" ¼" hole stainless fender washers in the compartment.

Replace the Ballast retainer and replace the screw. **DO NOT OVERTIGHTEN THE SCREW!**

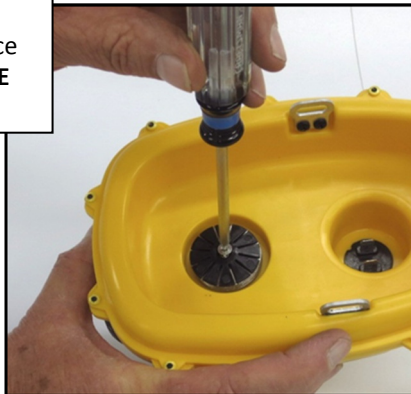

Verify that the ballast washer stack does not exceed the height of the ballast compartment. The battery will not seat and damage will occur!

IMPORTANT SAFETY INFORMATION

REMOVE BATTERY FROM UNIT AFTER USE

DO NOT STORE OR TRANSPORT UNIT WITH BATTERY INSTALLED

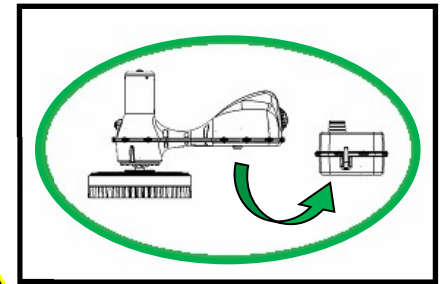
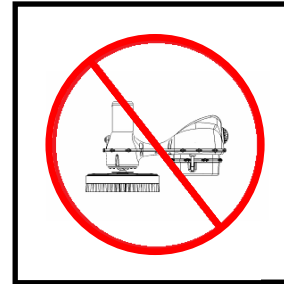

Plastic Parts Compatibility Warning

Use only Silicone based oils and grease for lubricating O-Rings and Plastic Parts. Petroleum based products may damage plastic parts over time.

Notes

Notes

Quick Start Guide

Inspect the unit

Remove the unit and accessories from the package. Verify that everything you ordered is there.

Check operation of Remora

Make sure the Variable Speed and Direction (VSD) dial (at rear of unit) is in "0" (Centered)

Install the battery, make sure the battery is pressed firmly into the battery well and the clips are securely snapped in place.

Press the pause button (front of unit) once. The unit will **not** start.

Slowly rotate the VSD. The unit will start and increase speed.

Rotate the VSD to the other side and test operation.

Return the VSD to "0" and press the pause button once.

Remove the battery from the unit.

Charge your Battery

Carefully insert the terminals of the charger into the contacts in the battery. The charger can only be attached one way. Battery is fully charged when all 4 green LEDs are solid green. This may take up to 10 hours for the first charge.

Install the Impeller to the brush as shown.

The bronze nut, Belleville washer and plastic washer come installed on the end of the shaft. Remove these components.

Make sure the flats on the hub fully engage the flats in the flex plate!

Install the brush assembly onto the Drive Hub

If you need to remove the Drive Hub, be careful not to lose the drive key, it's small!

Verify that the drive key and drive hub are properly aligned on the shaft.

Install the plastic washer, cupped Belleville washer and bronze nut in the order shown.

Tighten the bronze nut SECURELY. Grip the outside of the brush firmly and use the supplied ½" wrench to tighten.

Install the charged battery into the unit.

Make sure it is firmly seated and the clips are engaged correctly

Using Remora SOLO takes a little practice to get comfortable.
Give it some time and let the machine do the work!

Removing the battery from Remora SOLO, continued

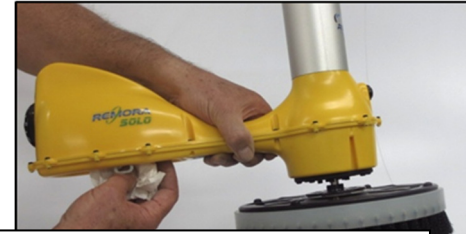

Still holding the unit upright, carefully wipe unit battery well with a towel.



It is now safe to flip the unit over. Carefully wipe battery with a towel.

WARNING! Carefully examine the Battery Terminals for any signs of water entry. The terminals should be bright silver in color. If they are greenish or pinkish in color, water has entered the battery! If water has entered the battery, DO NOT use, charge or ship the battery. Contact Remora Marine IMMEDIATELY for service or warranty and remove the battery to a safe place outdoors.

Place the damaged battery into a Metal Container. Store outdoors away from combustible objects, plants or furniture.

Operating Characteristics and Safety Features

Electronic Speed Control and VSD

Your Remora has a governor or torque limiter: The speed control in Remora Solo is limited to a fixed number of amps to prevent damage to the motor, connectors and electronics. If this limit is exceeded during use, the unit will stop, then restart within 1 second. **This is covered in detail on page 4 of this manual.**

If this occurs, it means **you are pressing too hard on the brush.** Change to a coarser brush and reduce pressure on the brush.

Battery Pack

The battery pack has a brain. It keeps track of charging, discharging and will protect against external shorts, overcharging and over discharging.

When the battery pack is almost fully discharged, you will experience a condition where the machine stops, but will restart within 2-3 minutes, then stop again within a minute or so. If this occurs, recharge the battery or replace with a fully charged battery.

Cleaning with your Remora SOLO, continued

Two-handed, right or left...



Benefits: Best twisting torque resistance for heavier cleaning, less tiring and adequate maneuverability, easy steering, fast access to VSD and Pause Button

Considerations: Does not leave second hand free for other tasks or for holding onto the vessel when cleaning submerged.



An additional benefit is to change the rotation of the brush from time to time, this helps to equalize wear on the brush for best life.

Change up your styles and rotation when using Remora for extended periods, it'll save you from getting sore!

Removing the battery from Remora SOLO

If the unit is wet you must follow this procedure!

Keep the unit Upright! This prevents water from penetrating the electrical contacts

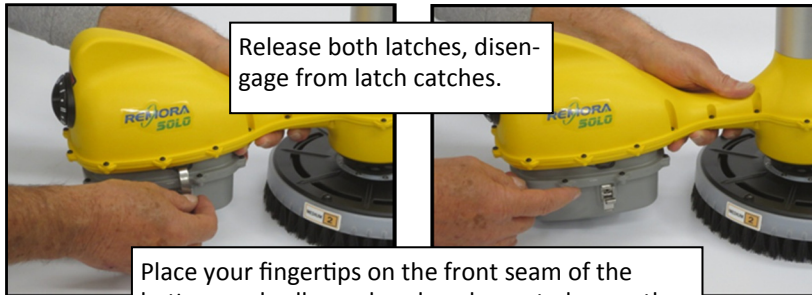

Release both latches, disengage from latch catches.

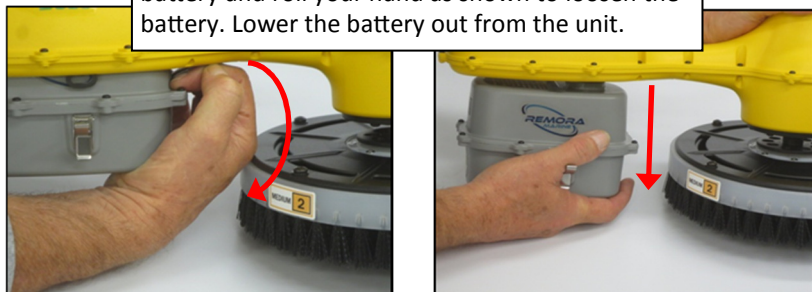

Place your fingertips on the front seam of the battery and roll your hand as shown to loosen the battery. Lower the battery out from the unit.

Spinner Nut Replacement



Due to electrolysis issues with the Aluminum spinner nut, this part has been replaced by the three components shown here. They must be installed in the correct orientation and sequence shown below. Tighten nut firmly!

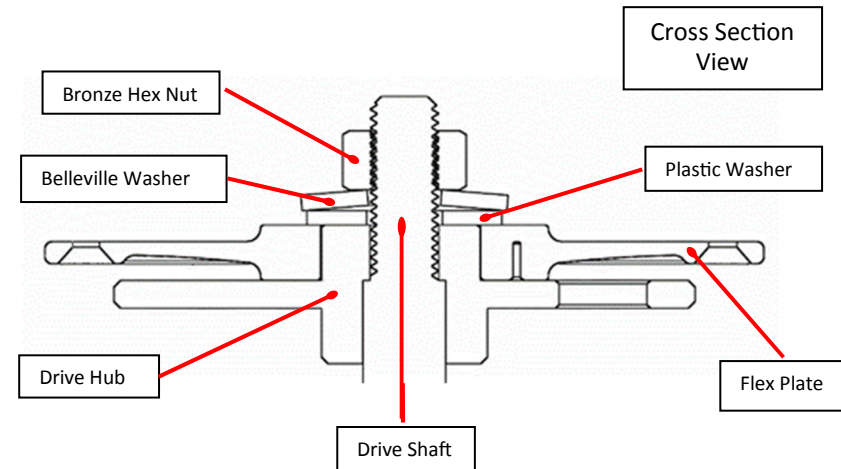
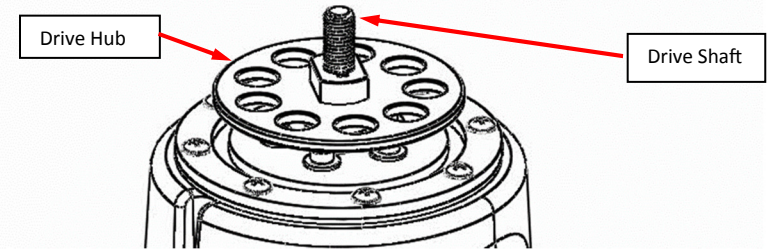
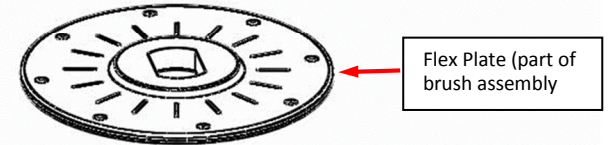
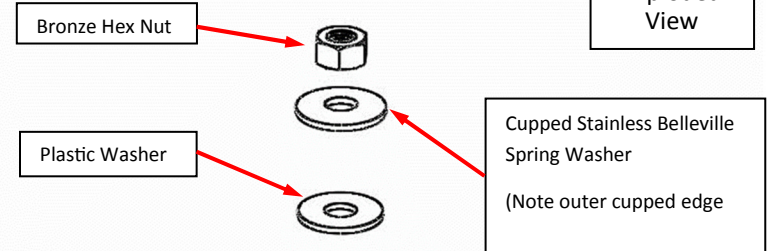

⚠ Caution!

Remora SOLO Uses Lithium Batteries.

Do Not Charge Battery unattended.	Do not disassemble or modify the battery.
Discontinue charging if battery or charger gets hot.	Keep batteries away from heat or fire.
Do not dispose of battery in fire.	Do not store batteries near flammable materials.
If a battery is dropped or damaged, discontinue use and remove battery to a safe, non-flammable location	Do not immerse battery in liquid unless it is firmly secured into the Remora Unit. The battery is not waterproof unless inserted into Remora.
Do not allow the battery contacts to get wet.	Do not short-circuit battery.
Do not allow metallic objects such as coins, tools, jewelry, etc. to touch battery contacts	Make sure that the battery is dry and the contacts are clean and dry prior to charging or use



Caution!

Remora SOLO is submersible and needs to stay waterproof!

Cautions	Best Practices
Do Not Drop Remora SOLO!! If dropped or bashed against a hard surface, do not use submerged.	Thoroughly rinse Remora with fresh water after each day's use.
Do not disassemble or modify Remora SOLO Remove battery when not in use.	Follow the regular maintenance actions described in this manual
Do not operate Remora SOLO at depths greater than 36 feet	Keep Remora and batteries out of direct sunlight for extended periods
Verify that the battery is securely clipped and firmly seated before use	Wipe battery o-rings and connector-well sealing surface before inserting battery.
Do not run Remora SOLO at any speed without water cooling for periods greater than 5 minutes	Don't store Remora SOLO at temperatures exceeding 100°F, keep it out of the back of your car on sunny days.
Always return VSD to "0" when handling Remora	

Cleaning with your Remora SOLO

How to hold onto your Remora SOLO

Remora has been designed to give you options on how you grip and control the machine. Each has Benefits and Considerations. There are three basic ways:

One-handed, grip around the waist, right or left handed



Benefits: Great for light cleaning, easy to grip, good maneuverability.



Considerations: High twisting loads on wrist when used at higher power settings.

One-handed, grip around the motor housing, right hand...

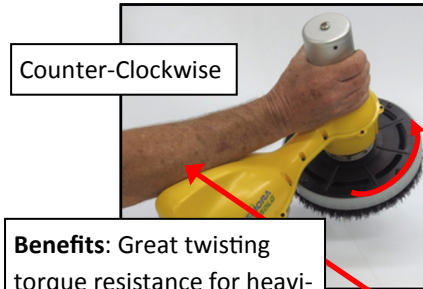

Counter-Clockwise

Benefits: Great twisting torque resistance for heavier cleaning, less tiring and adequate maneuverability.



Clockwise

Considerations: Less maneuverability than the waist-grip method.

Note: Forearm supported by fin

Or left hand...

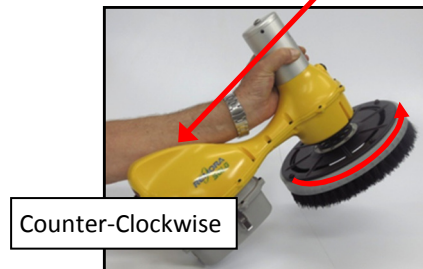

Counter-Clockwise



Clockwise

Operation of the controls

The controls consist of two elements:
Variable Speed and Direction control (VSD) at the rear of the unit, and
Pause Button, at the front of the unit

These two elements work together in a couple of ways.

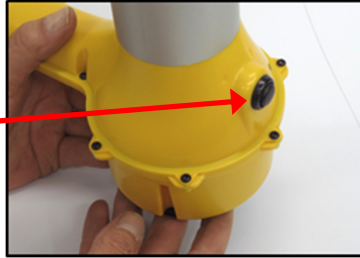

To start the unit:

Method One

- Press the pause button once
- Turn the VSD dial to your preferred setting, the unit will start and run at the selected setting.

Method Two

- Turn the VSD dial to your preferred setting
- Press the pause button once, the unit will start and run at the selected setting.

To stop the unit:

Press the pause button once. The unit will soft stop. If you want to continue cleaning at the same setting, press the pause button again and the unit will soft start and run at the previously selected speed and direction.

Turn the VSD dial to the "0" position. Unit will stop. The unit can be re-started by turning the VSD dial.

When finished, shut the machine off by pressing the pause button once and returning the VSD dial to "0".

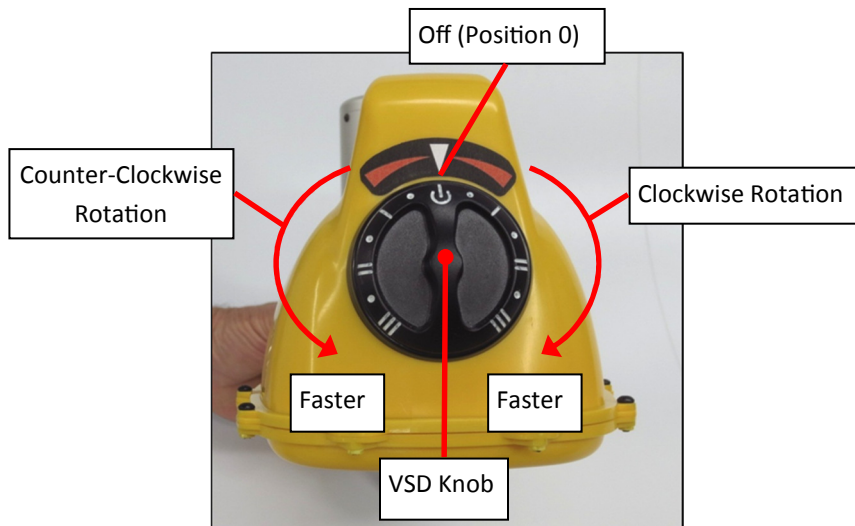

Charging and Batteries

Charging the Battery

The Standard Charger will charge your 21Ah battery in 5-8 hours, depending on discharge state of the battery. A 9Ah battery will charge in 3-5 hours.

Attach the Charger Adapter to the battery. The adapter can only go on one way.

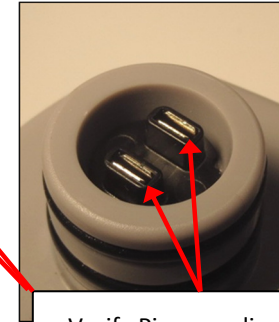

Verify Pins are aligned in center of female contacts!

Charger Adapter after installation:



Video Available: www.remoramarine.com or
<https://www.youtube.com/watch?v=xxfyi5BnmZQ&t=1s>

How to read the Charger Power Supply Lights:

Plug the AC cord into the power supply.

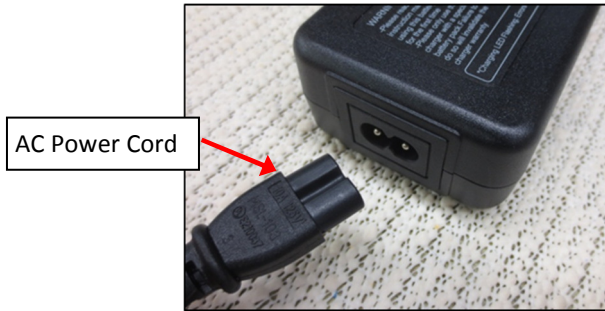

Plug the power cord into a wall outlet, The power supply can use from 90-264 Volts AC, 50/60 Hz . If not in the US, you will need an adapter for your country's AC outlets.



Plug the cable terminal into the adapter jack.

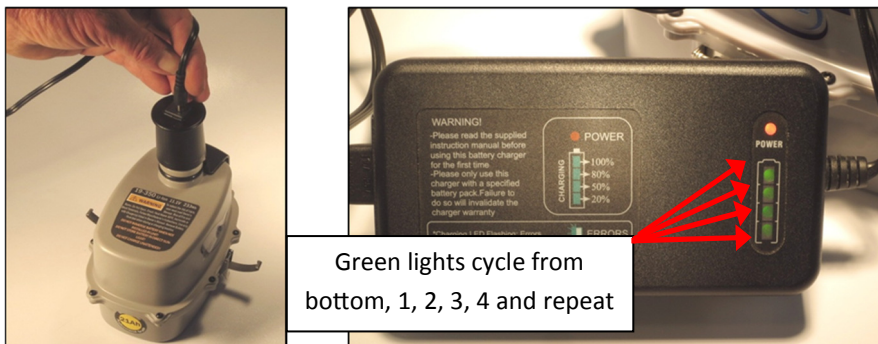

- When the battery first starts charging (when at shipping voltage of 10 volts or less), the green lights cycle 1, 2, 3, 4.
- When the battery reaches 20%, the first light will stay lit and the rest will cycle 2,3,4.
- At 50%, the lower 2 green lights will stay illuminated, and the upper 2 will cycle.

Choosing a brush

- Use the softest, least coarse cleaning brush or pad that will get the job done.
- If you have to clean large flat or lightly curved areas, use a flat brush.
- For curved or irregular surfaces, we have over 30 different brush types.
- Barnacles and excessively long growth should be removed or knocked down with a scraper before using Remora, or use one of our hybrid brushes that combine scraper blades with bristles.

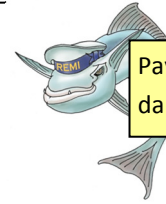

Pay attention! You don't want to damage expensive bottom paint.

Installing the brush to the impeller

Using the 4 Phillips head screws and washers, install the impeller to the brush. Tighten screws securely.

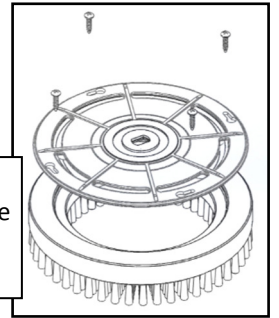

Installing the brush/impeller onto the Drive Hub

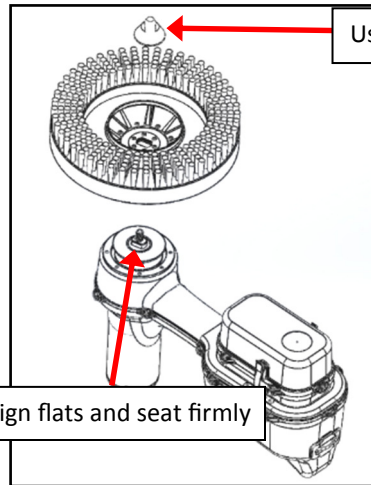

Install the brush assembly onto the hub, make sure the flats on the hub fully engage the flats in the impeller. If you need to remove the Brush Hub, be careful not to lose the drive key, it's small! Tighten the spinner nut SECURELY. Grip the brush firmly and use the supplied 1/2" wrench to tighten.



Remora's brush assembly serves a bigger purpose than just scrubbing. The impeller is actually a pump (Patented) that provides suction that applies pressure to the surface being cleaned. If you're smart, you'll learn how to use that to your advantage.

Using Your Remora SOLO

Installing the battery

Wipe the O-Rings and inner sealing surface with a soft cloth or wipe prior to installation. Make sure the contacts are clean and dry.



Apply a light coat of Silicone grease to O-Rings. Do not use automotive or Marine Grease!



Carefully align and insert battery from bottom, engage clips into catches then snap clips closed



Verify both clips are completely latched prior to using Remora SOLO



DO NOT SUBMERGE THE BATTERY OR UNIT UNLESS THEY ARE SECURELY MATED AND THE CLIPS ARE LATCHED FIRMLY

- When the battery reaches 80%, the lower three green lights will stay illuminated.
 - When the battery is fully charged, all 4 green lights will stay illuminated
- Remove the cable terminal from the adapter jack.
Unplug the charger from the wall outlet.
Remove the charger adapter from the battery.

Battery Charging Troubleshooting

If the Battery Charger Red light comes on and the green lights cycle one time from bottom to top when the charger is plugged into the battery:

Unplug the charger cap, unplug the AC Power cord from the wall outlet and wait 30 seconds. Repeat the process detailed on the previous page.

If the Charger Red Light comes on and the green lights cycle 1, 2, 3, 4 in a repeating pattern:

The battery may already be fully charged. Check the voltage with a voltage meter, if the battery voltage is 12.3-12.5 volts, the battery is charged and the charger will not charge it further. Use the battery until the voltage drops to a point where the charger will recognize it.

If the battery is lower than 12 volts but the charger is not performing as expected:
Unplug the cap, unplug the AC power cord from the wall and wait 30 seconds. Repeat the process detailed on the previous page.

If the Charger still will not charge the battery, contact us for warranty replacement or service.

WARNING! Carefully examine the Battery Terminals for any signs of water entry. The terminals should be bright silver in color. If they are greenish or pinkish in color, water has entered the battery! If water has entered the battery, DO NOT use, charge or ship the battery. Contact Remora Marine IMMEDIATELY and remove the battery to a safe place outdoors.

Place the damaged battery into a Metal Container. Store outdoors away from combustible objects, plants or furniture.



Bad!

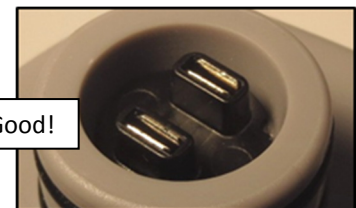

Good!

Daily Maintenance

Perform these tasks each day after use.

- ✓ Rinse the machine and brushes in fresh water while the battery is still in the unit. Wipe down the outside of the unit and battery with a soft towel.
- ✓ Remove the battery by following the Battery Removal Instructions on page 18.
- ✓ Inspect the battery O-rings and lubricate using silicone grease.
- ✓ Inspect the exterior of the unit for damage.
- ✓ Inspect the flex plate in the center of the Brush Impeller. Replace if warped or damaged.
- ✓ Inspect the battery latches and the latch catches on the lower part of the unit for wear or damage.
- ✓ If you are expecting to use the battery within the next two weeks, recharge the battery.
- ✓ Store the unit either hanging on a hook or strap or on its side in a box or plastic tote.
- ✓ Do Not store the unit brush down or on its brush, it will deform the flex plate which will cause the brush to wobble.
- ✓ Dry your brushes, if possible. The Nylon bristles absorb water and will become slightly softer over time.

Note Regarding Flashing Light Inside Remora

If you plug the battery in and look at Remora SOLO in a dark place, you will see a flashing red light in the rear portion of the unit. This is normal and shows that the speed control is armed and ready to use.

Periodic Maintenance

Lubrication:

Each two weeks, or 15 hours of use (whichever comes first) lubricate the areas shown below as described.

When removing the Drive Hub, take care not to lose the drive key.

Do not use petroleum-based lubricants on plastic parts. Use silicone-based only.



Clean & lubricate drive shaft, drive hub & Spinner Nut

Using the supplied 1/2" Wrench, remove the spinner nut and brush.

Remove the drive hub and drive key.

Clean the shaft threads with Isopropyl alcohol and a toothbrush, clean the drive hub and drive key with a swab to remove old anti-seize.

Re-lubricate as shown with anti Seize or waterproof grease

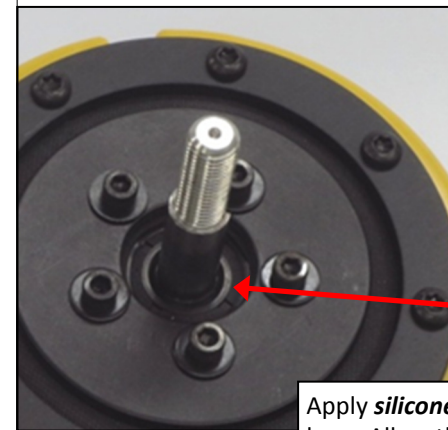

Clean & lubricate the shaft and shaft seal.

Inspect the shaft for debris, grass or algae wrapped around it. Remove debris with your fingers, tweezers or a tooth pick.

Be careful not to damage the seal!!

Where the shaft exits the seal, apply a small amount of Silicone Oil or 3-in-1 light oil as shown.

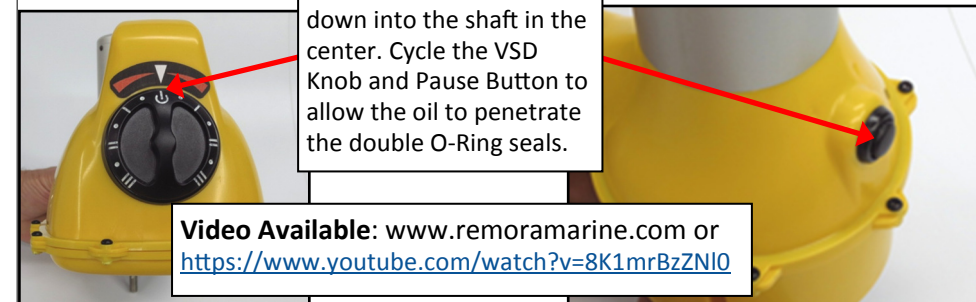

Video Available: www.remoramarine.com or <https://www.youtube.com/watch?v=8K1mrBzZNI0>