



Diving Hookah – 24v 250lpm



Operation and Maintenance Manual

Distributed In Australia By



Specifications

Power Source: 24v (1.8m Cables Fitted)

Motor: 24v Electric / 800 Watt / 40A / 2600 rpm

Compressor: 2 Cylinder / Oilless

Air Intake: 250 lpm (8.8 cfm)

Pressure - Tank: 8 Bar (116 psi)

Pressure - Outlet: Adjustable - 0 to 8 Bar (0 to 116 psi)

Tank: 7 Litre

Max. Number Of Divers: 2

Max. Recommended Depth: 20 metres

Unit Dimensions: 410mm(L) X 400mm(W) X 440mm(H)

Packaged Dimensions: 440mm(L) x 440mm(W) x 500mm(H)

Unit Weight: 23.5 kg

Packaged Weight: 25.5 kg

Noise: 70 dB

Warranty: 24 Months

Unpacking & Assembly

- Packing List
- Nardi Diving Hookah
 - Nardi Hose / Regulator (17m)
 - Operation & Maintenance Manual

Carefully remove the diving hookah and accessories from the box. Check that all the items listed above are included. Inspect the diving hookah carefully to ensure no damage occurred during shipping. Do not discard the packaging materials until you have inspected and satisfactorily operated the diving hookah.

This model Nardi Diving Hookah requires no assembly.

General Diving Hookah Safety

Diving can be dangerous at **ANY** depth. This diving hookah should **ONLY** be used by suitably trained persons. If you are not suitably trained, then you should undertake an accredited diving training course before operating the diving hookah.

- **Do Not** rely solely on the diving hookah. The diving hookah is an excellent primary source of breathing air, however it is a mechanical device which can stop supplying air at any moment and without warning due to a malfunction, disruption of power supply or disruption of air supply. A backup source of breathing air should always be present when diving. A “Bailout Bottle” also known as a “Pony Bottle” with integral regulator is an excellent backup air supply. Any backup air source needs to be sized sufficiently for a controlled ascent to the surface.
- **Do Not** dive alone.
- **Do Not** operate the diving hookah if any components are damaged or inoperative. Check the diving hookah and its accessories before use.
- **Do Not** modify the diving hookah or its accessories. Do not operate the diving hookah if it has been modified.
- The **Breathing Air** supplied to the diver is only as safe as the air at the diving hookah. The breathing air utilised by the diver is being drawn from the air at the diving hookah cooling fan. Be constantly mindful of the air quality where the diving hookah is located. Boat motors, generators, fuel supplies and batteries are all potential sources of breathing air contamination.
- **Cooling** of the diving hookah is reliant on airflow. Allow room around the diving hookah for sufficient airflow needed for motor and compressor cooling.
- Prior to any **Maintenance** being undertaken, ensure the diving hookah is switched off and drained of all pressurised air. For a 240v electric diving hookah, remove the plug from the electrical socket. For a 12v or 24v electric diving hookah, disconnect the electrical cables from the battery.
- Prior to any **Maintenance** being undertaken, ensure the diving hookah has cooled to room temperature.

Diving Hookah Operation

Location: Position the diving hookah on a stable and reasonably level surface. The diving hookah does not contain any lubricating fluids so the surface does not need to be perfectly level. Locating the diving hookah on an excessively sloped surface however could allow it to slowly 'creep' due to vibration while running.

Ensure there is sufficient room around the diving hookah to allow a free flow of cooling air to the cooling fan and from the cooling fan.

Be mindful that the diving hookah draws breathing air from underneath the cooling fan cover. The air being drawn into the cooling fan is the air that will be supplied to the diver. Be constantly mindful of the air quality at the cooling fan. Boat motors, generators, fuel supplies and batteries are all potential sources of breathing air contamination.

Power Connection: Connect the diving hookah only to a 24 volt battery. Connect the **RED** positive cable to the positive (+) battery terminal. Connect the **BLACK** negative cable to the negative (-) battery terminal. Ensure the connections are secure.

The unit is fitted with 1.8m cables. Extending the cables over greater distances will result in a drop in voltage reaching the electric motor. Lower voltages reaching the motor can cause damage and overheating. Additionally lower voltage will reduce the rpm of the motor thereby reducing the air output. Any extensions to the power cables should be carried out by a suitably qualified electrical specialist and may require upgrading the cables to a larger diameter than those supplied to compensate for additional cable length.

Hose Connection: The supplied hose/regulator assembly should be connected to the breathing air outlet located on the end of the diving hookah filter assembly. The hose connects by simply pushing the male hose connector into the female air coupling. Ensure that the chrome outer ring of the air outlet clicks back into place securely. Ensure that the connection is secure.

Switching The Diving Hookah On: The diving hookah's Electrical Control Box incorporates a red ON/OFF switch. The diving hookah is switched on by pulling the red switch to the upper position. The compressor will then run and pressurise the air storage tank to approximately 8 Bar. The compressor will then switch off automatically. The air storage tank pressure can be viewed via the uppermost pressure gauge. The compressor will cycle on and off as air is used by the diver, constantly re-pressurising the air storage tank to approximately 8 Bar.

Outlet Pressure Regulation: The outlet air pressure (air to the diver via the filter) is reduced by a pressure regulator. The pressure regulator is mounted beside the air storage tank pressure gauge and is fitted with its own pressure gauge which displays the regulated outlet air pressure. The pressure regulator can be adjusted by pulling the red adjustment knob up until it clicks and then turning the knob until the desired outlet pressure is obtained. Once adjusted, the knob should be pushed back into place until it clicks. The outlet air pressure will be factory set to approximately 4 Bar and adjustment is not generally necessary. Raising the outlet air pressure can place excessive strain on the diving air hose, fittings and 2nd stage regulator/mouthpiece.

After Use: After diving operations are completed the diving hookah should be switched off by pushing the red ON/OFF switch to the lower position. The air storage tank should be drained of air via the drain valve located on the lower side of the tank. Moisture which has accumulated in the tank during operation will also drain and this is quite normal. It is also normal for the moisture to contain discolouration.

Two Diver Operation

This model diving hookah is capable of supplying breathing air to two divers simultaneously by utilising a 'Nardi Additional Diver Kit'. The Additional Diver Kit includes a Nardi T-Coupling and an additional Nardi Hose/Regulator. The T-Coupling is fitted directly to the breathing air outlet on the diving hookah, allowing the connection of two Nardi Hose/Regulator Assemblies. See picture below showing the correct installation of a Nardi Additional Diver Kit.

NOTE: The Nardi T-Coupling is designed for installation directly to the breathing air outlet of the diving hookah. It is not designed to be fitted to an extension hose underwater. The connectors of the Nardi T-Coupling are not lockable and could be inadvertently disconnected if caught on a submerged object.



Maintenance

The diving hookah requires very little maintenance.

Air Leaks: The user should always be on the lookout for air leaks. An air leak will cause the diving hookah to run longer and more often than necessary which will be detrimental to the machine. An air leak will usually be audible. Air leaks may also be present if the air storage tank continuously loses pressure. Once switched on, the diving hookah should pressurise the air storage tank to approximately 8 Bar and the tank pressure should remain at 8 Bar until air is used by the diver. A suspected air leak can be easily located using soapy water. Any air leaks found should be rectified before continuing to use the diving hookah.

Breathing Air Filter Cartridge: The breathing air filter (mounted on the air storage tank) contains a replaceable filter cartridge. The filter cartridge should be replaced every 12 months. If the diving hookah is being used regularly in a commercial setting, then it may be necessary to replace the cartridge more frequently. The filter cartridge can be accessed by unscrewing the knurled aluminium end of the filter housing along with the diving hose connector. Replacement filter cartridges are available from AC Diving (Part Number AC036-101).



Service Kits: Service / Rebuild Kits are available for the diving hookah (Part Number EX041-160). The Service Kit includes replacement Piston Seals, Gaskets, O-rings and Air Suction Filters. A service kit may be required if the diving hookah has been operated extensively in a commercial setting or if the diving hookah has been overheated.



Spare Parts

All replacement parts are available from AC Diving. Parts Diagrams can be viewed below.

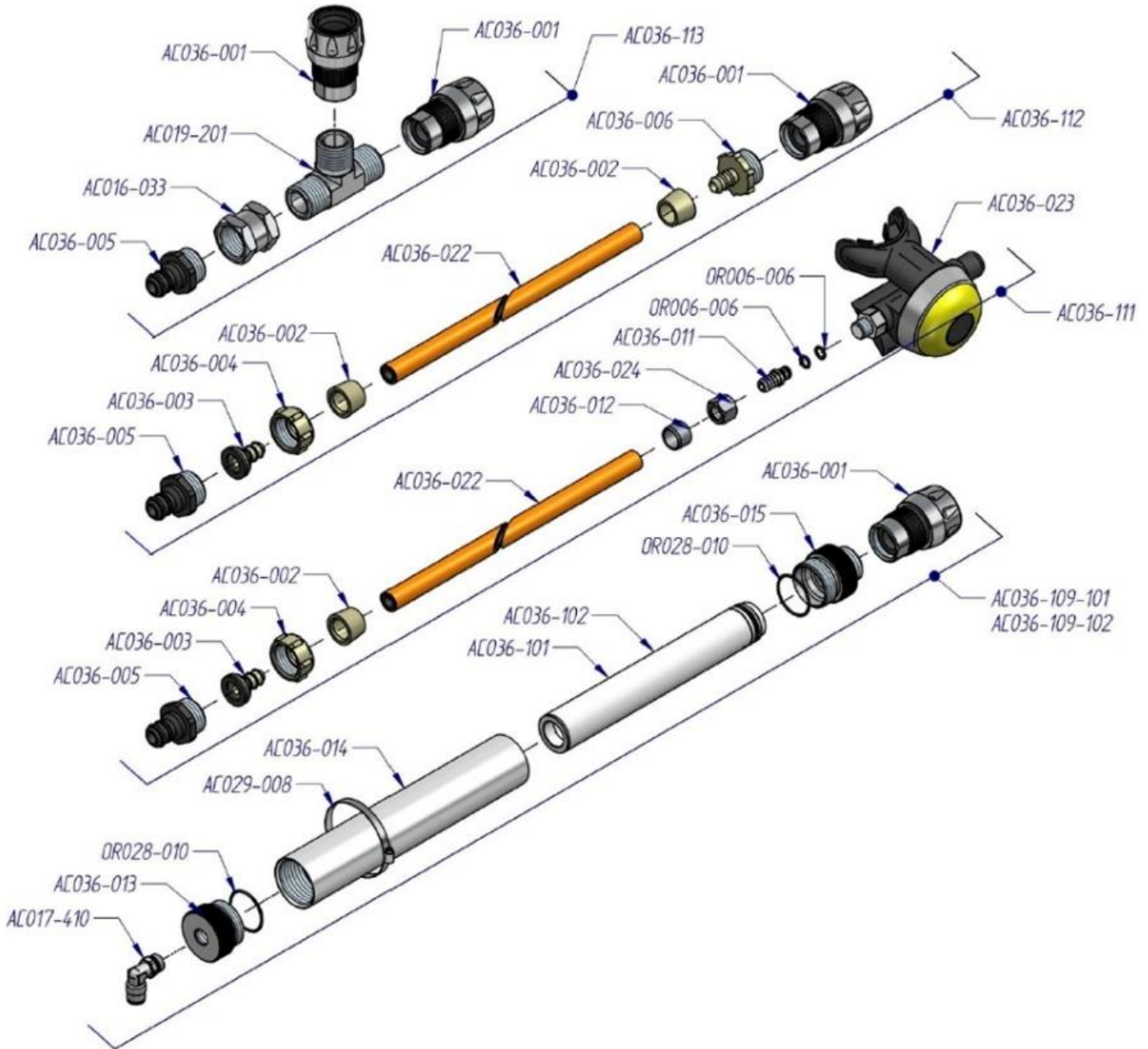

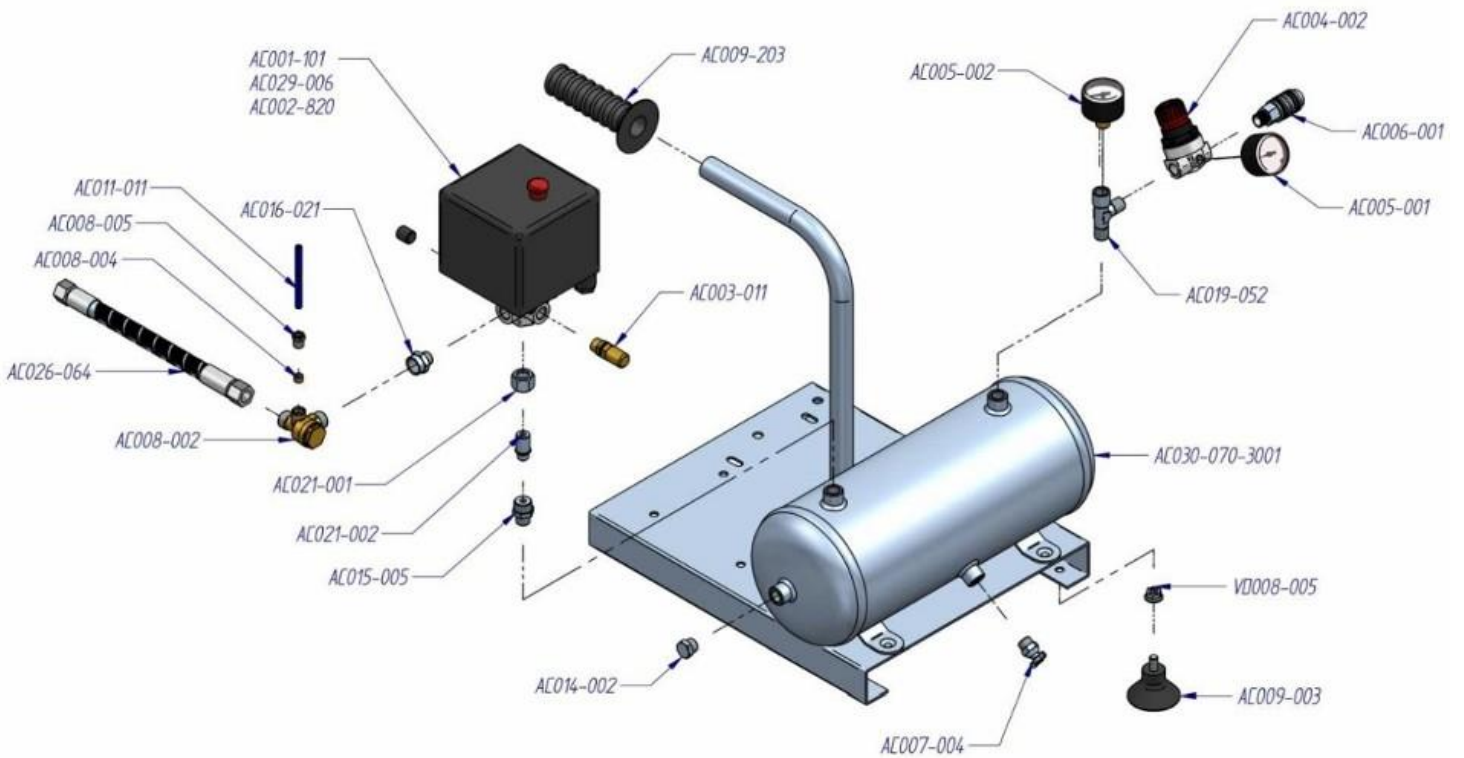
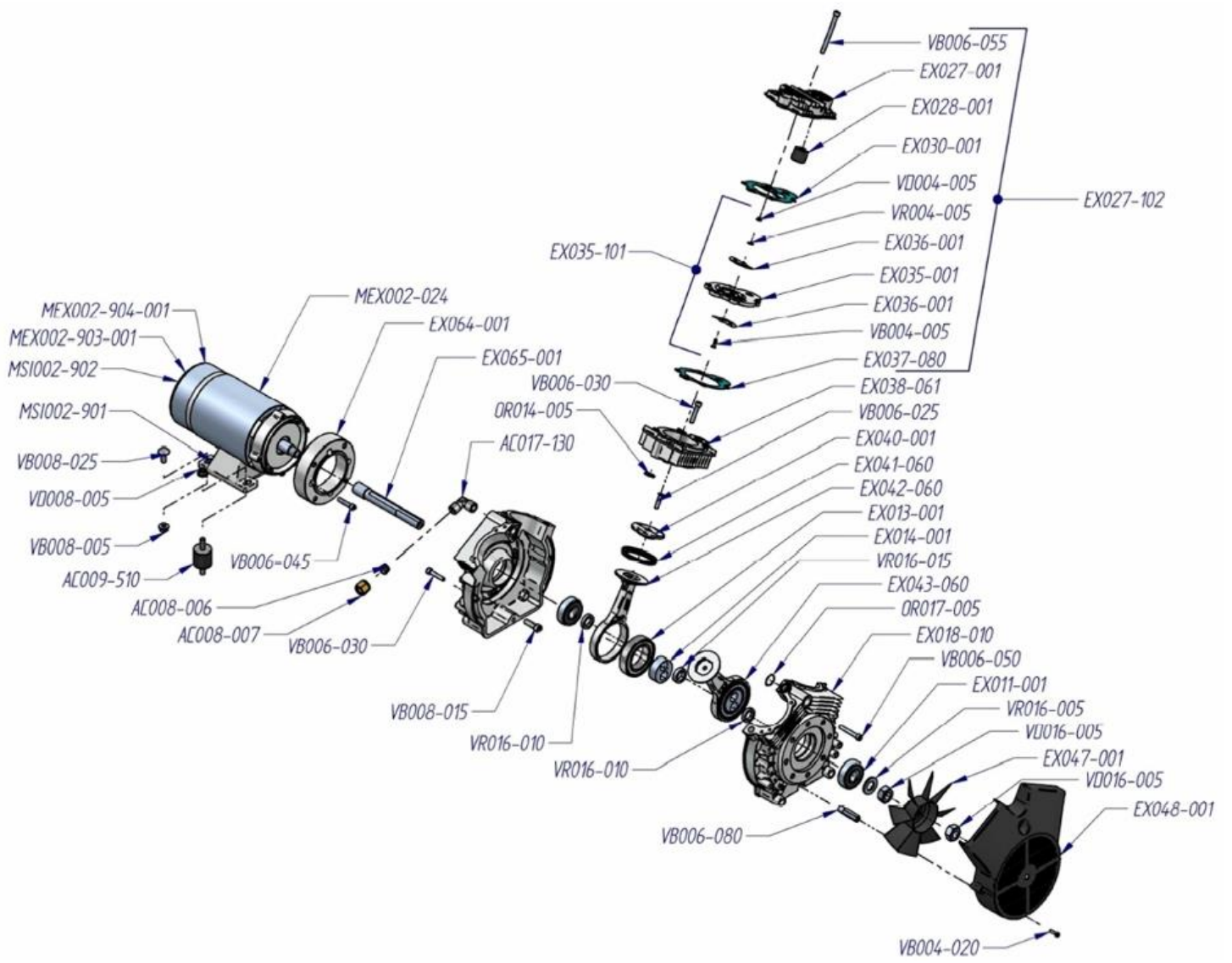

Warranty

Your Nardi Diving Hookah is covered by a 24 month warranty against defective components. The warranty does not cover normal wear and tear, nor does it cover defects caused by misuse or operation not in accordance with the supplied Operation & Maintenance Manual.

Contact Details

AC Diving

Phone: 0499 003 451

Email: info@acdiving.com.au

Website: www.acdiving.com.au